



1.25Gb/s InGaAs 5pin LC ROSA

PTCM967-428

Features

- *Data rates up to 1.25Gb/s*
- *High performance InGaAs PIN Photodiode with Transimpedance Amplifier (TIA)*
- *Operating wavelength range: 1250~1620nm*
- *Single +3.3V power supply*
- *Wide dynamic range*
- *LC package (5-pin)*
- *Case is isolated with GND pin*
- *RoHS compliant*

Application

- *SDH/SONET Transmission system up to 1.25Gbps*
- *Gigabit Ethernet*
- *1Gbps fiber channel*
- *Other applications*

Description

The PTCM967-428 is a high-performance 1310nm InGaAs photodiode and a transimpedance amplifier packaged for high-speed data communication.

The device inside packaged with InGaAs PIN and TIA. The PIN transduces incident light into optical current with high efficiency. The TIA converts the current signal into a voltage signal with a very low input noise current contribution. The TIA also can decrease the light to voltage conversion factor when the average incident optical power is relatively high. The golden wire's pull force is strictly tested to guarantee its fastness. The PTCM967-428's TO cap is sealed under the condition of dew point and airproof control. So it can provide the best work environment.

The miniaturized size LC adaptor with sleeve barrel and 5-pin LC package provide industry standard connection and the best inserting and drawing. Laser welding craftwork flow guarantee the device's stability. WTD reliability criterion strictly control each step of the device craftwork in order to ensure high reliability and the best performance.

It is designed for 1.25Gb/s SFF/SFP transceiver module. It is also available with a connector receptacle or as a single mode fiber pigtail. The device is applicable for 1310nm/1550nm optical fiber communication systems for 1.25Gb/s, typically showing high sensitivity of -28dBm.

Absolute Maximum Ratings

Parameter	Symbol	Unit	Min	Max
Storage Temperature Range	T_s	°C	-40	85
Relative Humidity	RH	%	5	85
Power Supply Voltage	V_{cc}	V	-	4.0
Photodiode Bias Voltage	V_{pd}	V	-0.5	20
Input Optical Power	P_{in}	dBm	-	3
Lead Solder Temperature	-	°C	-	260
Lead Solder Duration	-	S	-	10

Recommended Operating Conditions

Parameter	Symbol	Unit	Min	Typ	Max
Case Operating Temperature Range	T_c	°C	-40	25	85
Power Supply Voltage	V_{cc}	V	2.97	3.3	3.63
Photodiode Bias Voltage	V_{pd}	V	2.97	3.3	3.63
Wavelength Range	λ	nm	1250	1310	1620

Specifications (T=25 °C, unless otherwise noted)

Parameter	Symbol	Unit	Min	Typ	Max	Test condition
Electrical Characteristics						
Operating Current	I _{cc}	mA	-	30	39	No loads
Trans-impedance	Z _t	KΩ	-	15	-	Single ended
Output Impedance	R _o	Ω	-	50	-	Single ended
-3dB Bandwidth	BW	MHz	700	1100	-	
Low Frequency Cut-off	f _{Low}	kHz	-	50	110	-
Differential Output Voltage	V _{out}	mV _{p-p}	-	-	500	
Isolation Resistor between Case and GND pin	RI	MΩ	10	-	-	
Optical Characteristics						
Responsivity	R	A/W	0.80	0.85	-	1310nm
Sensitivity	S	dBm	-	-28	-27	NRZ, ER=10dB, 1.25Gb/s,
Overload	P _{in-max}	dBm	-3	-	-	PRBS 2 ²³ -1, BER=10 ⁻¹⁰

Pin Description

PTCM967-428		
Pin	Description	Bottom View
1	Vcc	
2	OUT-	
3	OUT+	
4	Vpd	
5	GND	

Package Outline

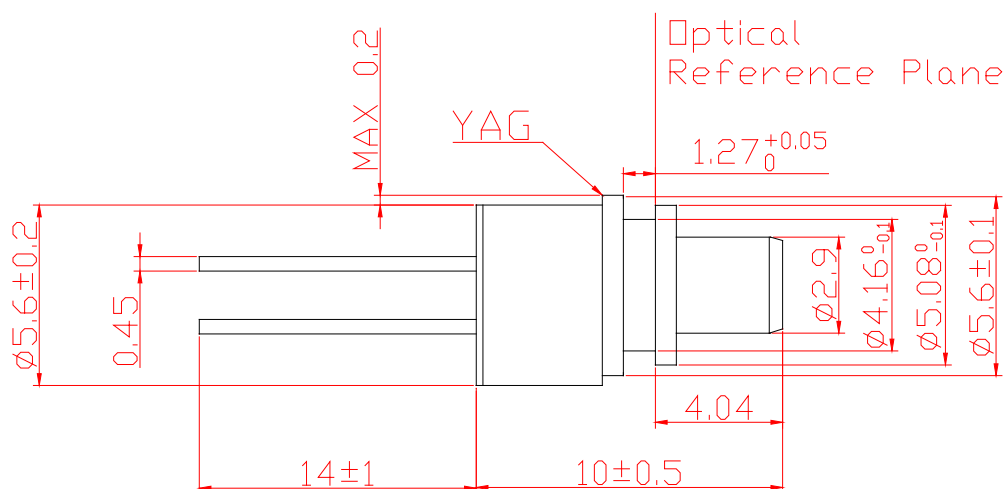

Regulatory Compliance

Feature	Test method	Performance
Electrostatic Discharge (ESD) to the Electrical Pins	MIL-STD-883E Method 3015.7	>500 V

Ordering Information

Part No.	Specifications						
	Package	Data-rate	Detector	Sensitivity	Overload	Top	Others
PTCM967-415	5pin LC ROSA	1.25Gb/s	PIN+TIA	< -27dBm	-3dBm	-40~85°C	+3.3V, RoHS

WTD reserves the right to make changes to the product(s) or information contained herein without notice. No liability is assumed as a result of their use or application. No rights under any patent accompany the sale of any such product(s) or information.

Edition 2009-12-01

Published by Wuhan Telecommunication Devices Co.,Ltd.

Copyright © WTD

All Rights Reserved.